



SENSORS TECHNOLOGY PVT. LTD.

AM-51 DEEN DAYAL NAGAR, GWALIOR, MP 474020, INDIA

TEL: 0751-2470680 FAX: 0751-4065716 www.sensorstechnology.com/

CSP1M MCP/Channeltron CSP + Discriminator

Specifications:

Charge Amplifier Section:

Signal at input: 0-4pC negative charge in 1ns-200ns pulse 0 to -200mV into 50-Ohms
Amplifier Gain: 1V/pC

Input Connector: SHV rated for 12kV

Signal isolation from anode HV supply: 4kV

Input protection: Protected to +/-10mA

Amplifier Input Stage: Low Noise Fast JFET

Maximum pulse rate: 1MHz

Discriminator Section:

Discriminator level set: 10 turn pot

Discriminator output: 0-3.8V TTL pulse

Output signal rise and decay time: <10ns

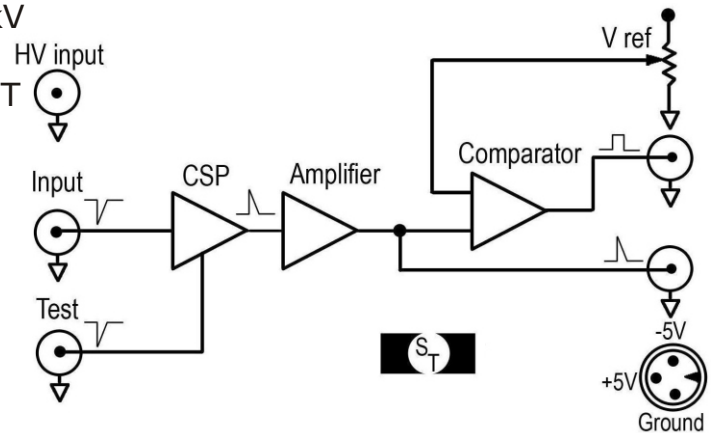

External Power Source:

DC power: +5V 500mA and -5V 500mA thru connector on back panel

Casing:

Shielded 3mm thick Aluminum casing, shielded from all sides in rectangular casing.

Warranty:

12 months free repair at our workshop located at Sensors Technology, Gwalior, MP

